

LIGHT EMITTING DIODES 1.6÷4.6 μm

Model LED23-PR

2.35 mm 0.8 mW

•Light Emitting Diodes **LED23-PR** are designed for emitting at a spectral range around 2350 nm. Heterostructures (HS) are grown on GaSb substrates. The output emission can be modulated by current flowing in a forward direction.

•Light Emitting Diodes **LED23-PR** are developed for using in optical gas sensors and medical diagnostics. They have stable output power and lifetime more then 10000 hours.

•Related products: **LED23-PR** can be used in optical pair with our photodiodes **PD25**. Our standard **LED Driver** provides power supply of **LED23-PR** in two recommended here regimes (Quasi-CW and Pulsed).

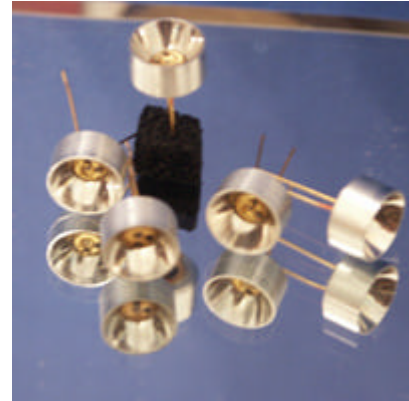

Parameters	Min	Typ	Max
Wavelength, μm	2.30	2.35	2.39
FWHM, μm	0.17	0.22	0.27
Optical Power, mW			
Quasi-CW @ 200 mA	0.6	0.8	1.0
Pulsed@1A	12	16	20
Switching Time, ns	10	30	50
Operating Temperature Range, °C	-240÷+50		
Emitting Area, μm	300x300		
Soldering temperature	260 °C		
Package	TO-18 with Parabolic Reflector		

Recommended regimes of operation

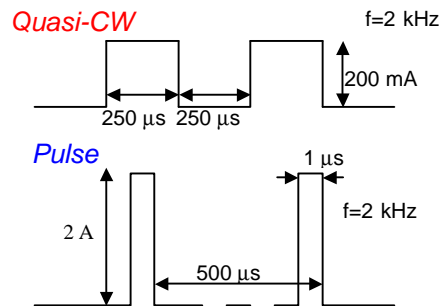

Package TO-18 with Reflector

